

Article

Fuzzy Efficient Energy Smart Home Management System for Renewable Energy Resources

Ronggang Zhang ^{1,*}, Sathishkumar V E ²  and R. Dinesh Jackson Samuel ³¹ Business School, Northwest University of Political Science and Law, Xi'an 710122, China² Department of Information and Communication Engineering, Sunchon National University, Suncheon 13557, Korea; sathishkumar@scnu.ac.kr³ Faculty of Technology, Design and Environment, Visual Artificial Intelligence Lab, Oxford Brookes University, Oxford OX3 0BP, UK; rsamuel@brookes.ac.uk

* Correspondence: zrg1168@126.com

Received: 17 March 2020; Accepted: 4 April 2020; Published: 13 April 2020



Abstract: This article provides a fuzzy expert system for efficient energy smart home management systems (FES-EESHM), demand management, renewable energy management, energy storage, and microgrids. The suggested fuzzy expert framework is utilized to simplify designing smart microgrids with storage systems, renewable sources, and controllable loads on resources. Further, the fuzzy expert framework enhances energy and storage to utilize renewable energy and maximize the microgrid's financial gain. Moreover, the fuzzy expert system utilizes insolation, electricity price, wind speed, and load energy controllably and unregulated as input variables to enable energy management. It uses input variables including insolation, electrical quality, wind, and the power of uncontrollable and controllable loads to allow energy management. Furthermore, these input data can be calculated, imported, or predicted directly via grid measurement using any prediction process. In this paper, the input variables are fuzzified, a series of rules are specified by the expert system, and the output is de-fuzzified. The findings of the expert program are discussed to explain how to handle microgrid power consumption and production. However, the decisions on energy generated, controllable loads, and own consumption are based on three outputs. The first production is for processing, selling, or consuming the energy produced. The second output is used for controlling the load. The third result shows how to produce for prosumer's use. The expert method can be checked via the hourly input of variable values. Finally, to confirm the findings, the method suggested is compared to other available approaches.

Keywords: fuzzy efficient smart home management system; renewable energy resources; smart microgrids; fuzzy expert system

1. Introduction and Importance of the Smart Home Energy Management System

Renewable sources have experienced significant (annual) growth rates over recent decades, mainly in terms of solar power, which offers sustainable, low-cost, eco-friendly, accessible power to a mass-production range [1]. Renewable energy units close to the energy load are beneficial because the energy losses of transport are virtually reduced [2]. The energy required for a typical smart home is relatively less and can mainly be supplied from renewable sources [3]. Given the two major renewable energy sources are the sun and wind, the effective production of electricity from such sources is one of the main objectives of the energy industry [4]. Although these energies seem free, with less negative influence, it can only be determined by how these energies are collected and utilized whether or not the system is sustainable [5]. In this context, it can be stated that if the overall system's output is great and energy generated is handled in an approach that minimizes negative influences on the power grid,

the energy is effectively sustainably harvested from these resources [6]. In other words, the energy produced from renewable energies is more effective when locally used or stored instead of being injected into the grid [7]. Therefore, a small production facility with highly dynamic activity does not interrupt the power grid. Moreover, to provide an optimal solution for the power grid to be employed only as a battery storage capacity buffer, wind turbine power, and the number of panels, can be held to enable an overall cost-efficient design [8]. Figure 1 shows the microgrid system with renewable energy resources.

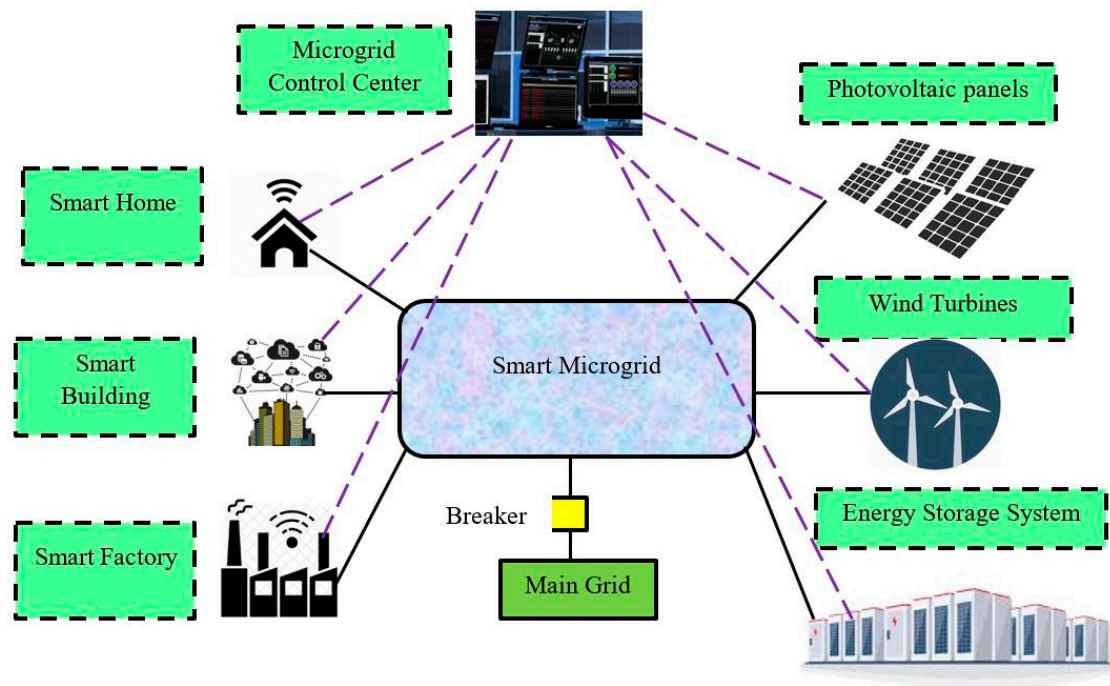

Figure 1. Microgrid system with renewable energy resources.

In the area of optimum complex systems control, constancy is required to increase smart grids and real-time pricing, and the growth of distributed power generation, as well as electric vehicles and storage systems [9]. The major purpose of the study is to solve the issues faced by new electricity consumers and producers trying to maximize the advantages of modern technology to control their energy [10]. The complexity issues vary according to energy storage, real-time electricity pricing, power management, and distributed energy generation from Renewable Energy Sources (RES). A system with storage capacity, renewable energy, and controllable loads requires a controller to decide how the energy within a device can be optimally controlled. The energy generated in these systems can be used by the system, sold in power grids, or stored in batteries [11].

For future renewable systems, all energy-dependent applications have to be incorporated into a network that can be centrally regulated to achieve the best balance for cost-benefit [12]. Nowadays in many countries, the construction of a smart city has become a global necessity owing to the huge ecological, social, and financial benefits it can bring [13]. Smart use of electricity on the demand side plays an important role in increasing consumers' quality of life and energy management and affects the way people use their power daily. Smart home energy management systems with microgrids are vital to support smart grids (SG) and efficient demand-side management (DSM) to reduce total energy costs [14]. Microgrids are classified as low- and mid-voltage networks comprising renewable distributed generating units of various kinds, scheduled loads, and storage systems that transmit or connect local loads [15].

In this study, a fuzzy expert system for efficient smart home management systems (FES-ESHMS) has been proposed for renewable energy resources. An optimum hydrogen/battery hybrid wind

turbine/photovoltaic energy management system based on fuzzy logic has been proposed for the smart home energy management system. Therefore, it is very effective to use fuzzy logic to promote the introduction of renewable energy into domestic or decentralized small grid applications. The power grid can be utilized to produce electric energy. This allows for the best cost-performing solution with limited storage capacity and optimum use of renewable energy.

The main contribution of the paper is:

- To propose a fuzzy expert system for efficient energy smart home management systems (FES-EESHM) for renewable energy resources.
- The proposed FES-EESHM system with microgrid incorporates smart metering for real-time pricing, many distributed generation renewable sources, smart controllable appliances, an energy storage system (ESS), and major electricity utilization.
- The experimental results demonstrates high performance and cost-effectiveness.

The paper is structured as follows: Sections 1 and 2 introduce the existing method of smart home energy management systems. In Section 3, a fuzzy expert system for efficient energy smart home management systems (FES-EESHM) is proposed for renewable energy resources. In Section 4, the experiment results are demonstrated. Finally, Section 5 concludes the research paper.

2. Literature Survey and Features of this Research Paper

Chehri et al. [16] proposed a fuzzy based energy management system (FEMAN) for a greenhouse utilizing hybrid grid solar power. Using RE technologies and services might help answer this question. FEMAN is a method for developing integrated systems that provide device functionality as services for end-consumer requests. With the goal of reducing the building's energy consumption while maintaining a set comfort, they suggested a fuzzy-based energy management system. Intelligent house energy control focused on the Mamdani fuzzy inference system, which was conceived to decrease householder prices.

Samuel et al. [17] suggested a multi-output adaptive neuro-fuzzy inference system (MANFIS)-based home energy management system. The fuzzy controller can interrupt various appliance operations and exchange consumers' excess energy via the grid, thereby decreasing power flow and the cost of electricity. The suggested method is checked against inputs for validating the results with insolation, day-to-day data of wind speed, controllable and uncontrollable power appliances, and electrical energy quality. Control system performance determines how to manage the appliances' power consumption, production, and planning. The result shows that the cost of electricity decreased by 58%, peak power usage decreased by 45.6%, and the peak-to-average ratio decreased by 74% after the suggested policy was implemented.

Prakash et al. [18] introduced the fuzzy logic-based smart home energy management system (FL-SHEMS). The battery management system connects the battery to the generator or for storage while the charging system determines whether the battery or grid charge is connected according to various factors, such as the charge size, the battery condition, and the grid availability. The energy management method is carried out with fuzzy logic and checks for different testing conditions are carried out with the hardware module. The energy expended with and without SHEMS is significantly improved. Minimizing household energy consumption plays an important role in reducing our total carbon footprint. As can be seen with the comparative findings provided in this report, SHEMS is an effective option. In-house profiles that include both light and medium loads in the home can be analyzed. The analysis is feasible.

Chekired et al. [19] suggested a fuzzy logic energy management system (FLEMS) for a photovoltaic solar home. A process was developed to control the domestic energy demand based primarily on the energy available from the PV system and on a load priority that was tailored to meet the energy needs and comfort of the customer. The developed fuzzy home energy management system has made it possible to save 27% and 26% of energy in winter and summer respectively as compared with the use

of the same home under similar conditions without any energy management and/or simply utilizing a simple load priority. The load profile, the load status (SOC), and the priority requirement for the system take account of the output profile. The simulation showed that the adopted fluorescent strategy in the studied solar home can achieve optimum energy management.

Breban et al. [20] initialized the fuzzy logic energy management algorithm (FLEMA) for a residential power system utilizing renewable energy sources. The major features of the design are the thermal loading pump that generates thermal energy as the system's main electric load, and the vehicle storage portion that can be recharged from renewable sources. The algorithm obtainable provides for the employment of an effective energy control system using fuzzy methods so that renewables are used as widely as possible. Results indicate that the battery charge and the heat pump can be supplied from renewable sources for most of the electricity. With this method, renewable energy can be spread to charging a battery and feeding a heat pump that generates thermal energy. The results showed that for the first case (the discharged battery is not charged during vibration) the battery charge is around 96% and for the second, the thermal energy level from renewables is around 89%, and for that case around 83% (the sound battery is discharged). The remaining energy needed must be provided by the grid.

To overcome these issues, in this paper, a fuzzy expert system for efficient energy smart home management systems (FES-EESHM) is proposed for renewable energy resources. Concurrent decision making with modified input data is possible through the implementation of fuzzy logic. Fuzzy logic allows users to change the rules and to change the function of their controller because of its relation with linguistic expressions. This article presents a fuzzy control unit for smart home management or microgrids which can delay the use of controlled loads and includes the production of electricity utilizing wind turbines and PV panels. It is a smart controller designed with real-time data and future predictions of energy sources and real-time costs in mind to maximize usage and output, and store energy. This controller offers the option of planning operating plans for the future, as data can be forecast an hour or one day in advance.

3. Fuzzy Expert System for Efficient Energy Smart Home Management System

In this paper, a fuzzy expert system for efficient energy smart home management systems (FES-EESHM) is proposed for renewable energy resources. For the proposed fuzzy expert system, the membership functions and histogram of the electricity cost are provided to demonstrate the connections between membership functions and real information. Combining several rules, the entire knowledgebase can be described with a compact computational depiction. The entire knowledge base is described by a list of rules. The rules can be reformed to maximize profit, reduce the cost of energy or anything else that is the user's goal. In cooperation with utilities, rules for reducing CO₂ emissions can be established. De-fuzzification is the next and last step. De-fuzzification converts the device inference into an output signal. It is a process that requires the result of the aggregation—basically, a cross-section surface—to become a signal to be recognized by the process. The controller output has to have a unique value, a real one indicating a decision. These values can be modified to the type and size of the consumer. All membership features are modified to cover the stated input ranges. The input data histogram is best represented by the number and membership function values. The process of the fuzzy expert system for SG control is represented in Figure 2.

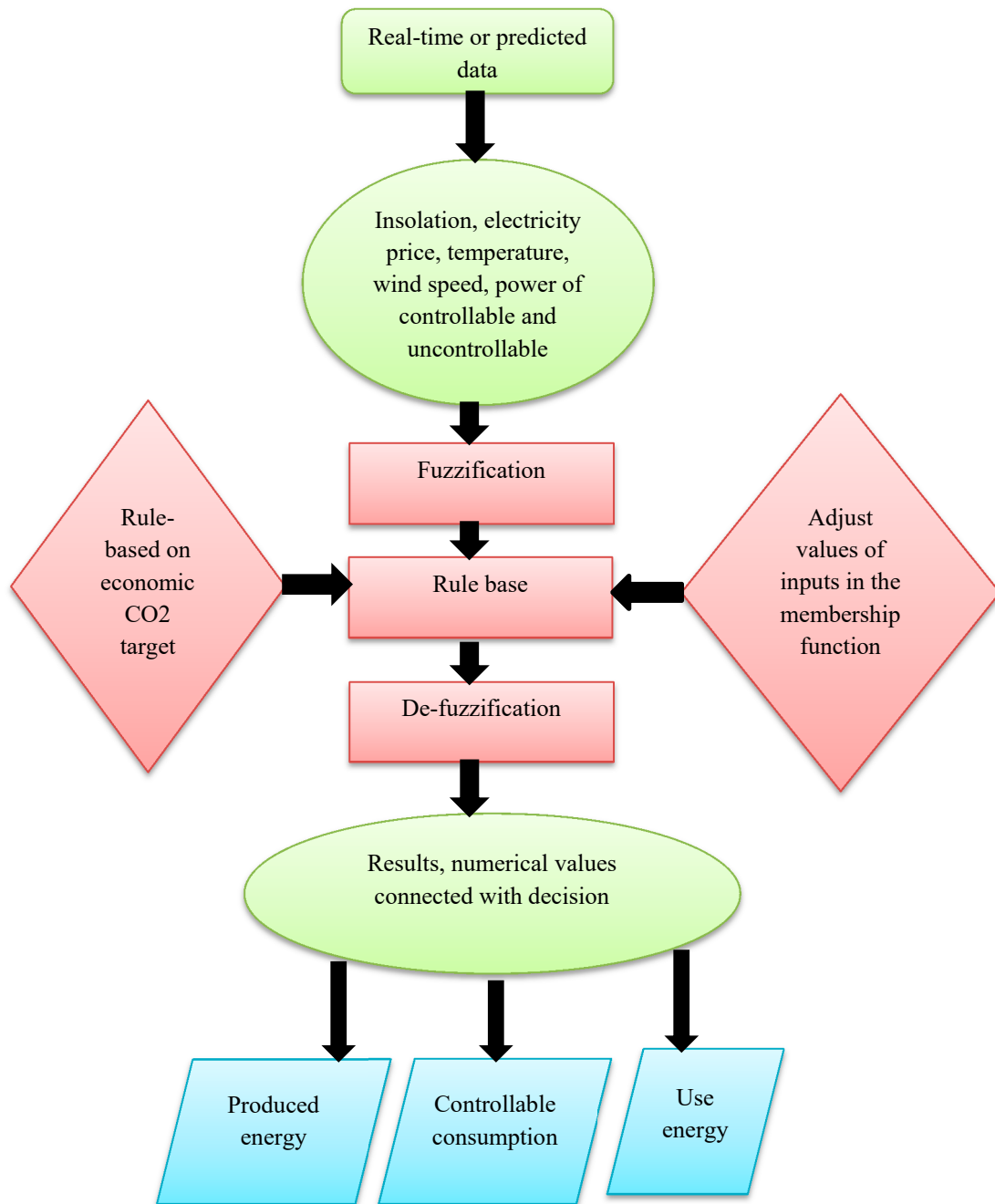

Figure 2. Fuzzy expert system.

This paper focuses on the residential electricity needs of many customers. The incorporation of distributed generation, energy storage systems, and smart grids are satisfying the energy demand of residential areas. Smart home energy management consists of a smart meter, energy storage system, a control and monitoring unit, and scheduled appliances. The smart meter helps to collect price-incentive information, demand response, and real-time pricing from the energy management program. It plays an important role in smart grids, which facilitate two-way customer and SG communication. A variety of advanced technologies, such as Wi-Fi and ZigBee, interact with the FES-EESHM controller. The systems are classified into two different modules: smart appliances (SA) and traditional appliances (TA) based on their energy consumption patterns and the interaction between them.

Power Consumption of the smart appliances is considered according to three parameters which are listed as follows such as Total power usage, power consumption, and time period. The electricity consumption depends on loads from appliances such as water coolers, refrigerators, and air conditioners. These loads can be used for the minimization of large power consumption, high-speed to average power, and cost of electricity. This type of load can be depicted by B_{qe}^w where consumption of energy is provided by G_R^{qe} and q_R^j is the rating of power. The energy consumption is denoted as follows:

$$G_R^{qe} = \sum_{j \in B_{qe}^w} \sum_{r=1}^R (q_R^j \times Y_r) \quad (1)$$

as inferred from Equation (1) where Y_r represents the status of the appliances.

The power elastic appliance daily price can be calculated as follows:

$$D_R^{qe} = G_R^{qe} \times \varphi(r) \quad (2)$$

As described in Equation (2) where D_R^{qe} denotes the power elastic appliance overall electricity cost, $\varphi(r)$ denotes the electricity cost per timeslot.

Moreover, if needs be this load can be moved, shut down, and disturbed at any time. It can execute the task at a different time without mortifying the recital of the operation. B_{qe}^w is the appliance class and consumption of energy as depicted by $G_R^{re} D_R^{eb}$. The overall power consumption is calculated by,

$$G_R^{re} = \sum_{j \in B_{re}^w} \sum_{r=1}^R (q_R^j \times Y_r) G_R^{re} = \sum_{j \in B_{qe}^w} \sum_{r=1}^R (q_R^j \times Y_r) \quad (3)$$

The time elastic appliance day-to-day cost of electricity can be calculated as,

$$D_R^{re} = G_R^{re} \times \varphi(r) \quad (4)$$

as shown in Equation (4) where D_R^{eb} denotes the overall electricity cost in time elastic loads.

Essential appliances include an electric kettle, oven, and electric iron that have constant loads of power. Their operation can shift only before they are switched on. If these loads start working, then they are not permitted to be disturbed until the operation is accomplished. This is denoted as B_{eb}^w rating of the power $q_R^j q_R^j$ and overall consumption of power G_R^{eb} . Daily consumption of energy is evaluated as follows,

$$D_R^{eb} = G_R^{eb} \times \varphi(r) \quad (5)$$

as inferred from Equation (5) where D_R^{eb} denotes the essential appliances' electrical energy consumption cost. Figure 3 shows the efficient energy smart home management system based on a fuzzy logic system.

Renewable energy sources integration is required to optimize the power grid at the right time to increase efficiency. Renewable energy's variable nature makes it inefficient to change the power generation method. ESS are one of the effective ways to smooth these variations. The production of trade surpluses is another benefit for neighboring customers. Based on the generation of tradable residential consumer power, RES energy is divided into three modules: the smart energy consumer (SEC), the grid energy consumer (GEC), and the trading energy consumer (TEC). The smart energy consumer gets energy from the renewable energy-generating neighbor consumer as well as utilizing their energy to fulfill the demand for energy. Via contracts for smart energy management, the trading energy consumer generate and stores its energy with all consumers. Figure 4 shows the renewable energy sources integration model.

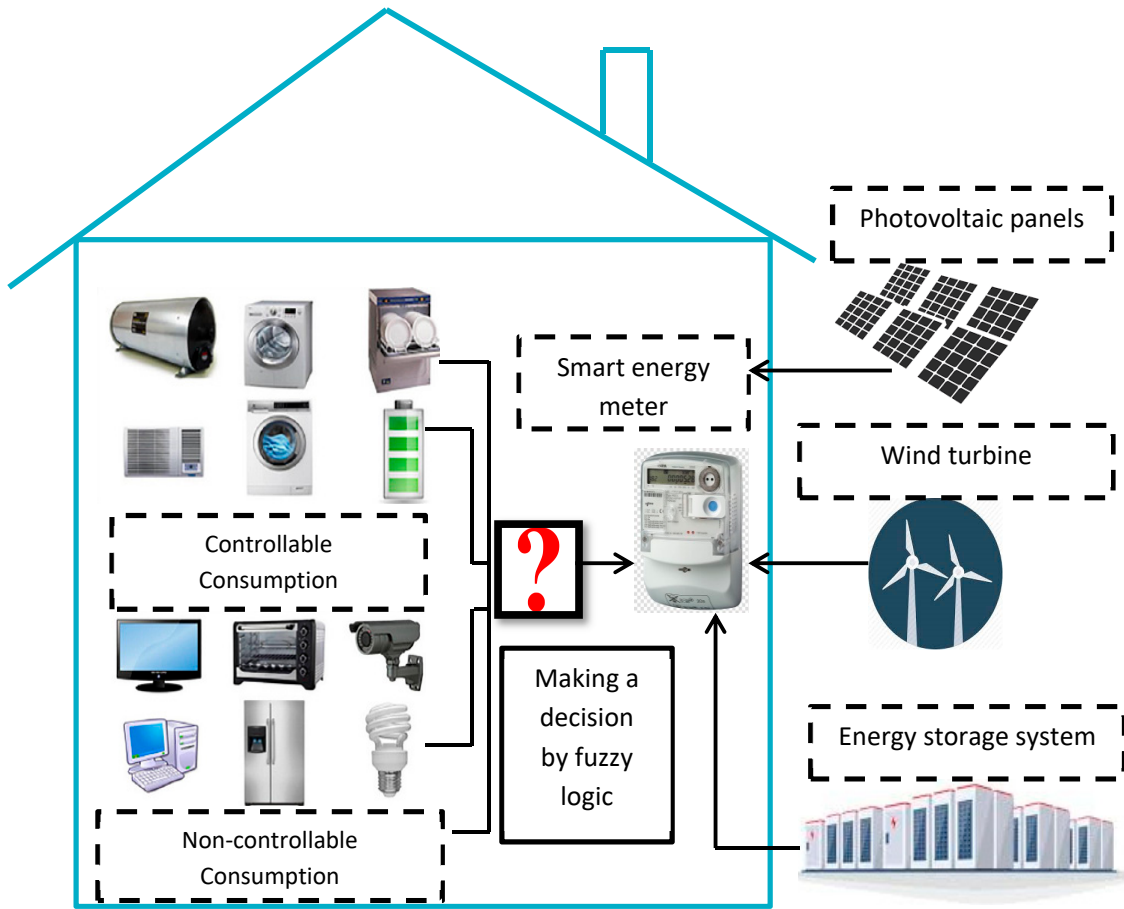

Figure 3. Fuzzy logic-based energy management system.

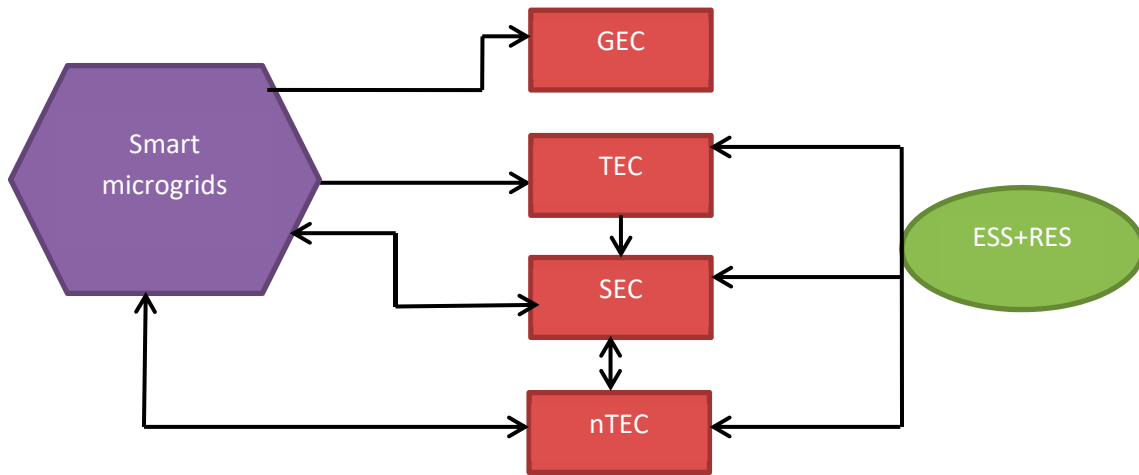

Figure 4. Renewable energy sources integration.

The grid energy consumer (GEC) does not have RES and depends on microgrid energy. $C_h(r)$ units are the grid energy consumer’s energy demand per timeslot. The energy demand of the grid energy consumer is controlled as $C_h(r) \leq C_{h, max}$. High energy usage and power cost can be reduced when loads are shifted from off-peak to on-peak hours. The energy consumption of the grid energy are estimated as follows,

$$G_h = \sum_{r=1}^R G_h(r) \tag{6}$$

The smart energy consumer (SEC) satisfies their energy demand via ESS, smart grid stations, and RES. $C_w(r)$ units are the smart energy consumer's demand for energy. Demand per slot of time should not reach beyond the extreme claim $C_w(r) \leq C_{w, max}$. Using their own renewable energy, the smart energy consumer satisfies their demand. If the smart energy consumer's demand maximizes the available energy from RES $T_w(r) < C_w(r)$, it utilizes the power accessible, and unfulfilled demands are the remaining demand as follows:

$$C_w(r) - T_w(r) = C_w^v(r) \quad (7)$$

The amount of power available from neighboring trading energy consumers, electricity grid stations, and energy storage systems should fulfill the demand residue system expressed as,

$$A_{c,w}^e(r) + \sum_{r=1}^R T_{w,R}(r) + G_h(r) = C_w^v(r) \quad (8)$$

$$\sum_{r=1}^R T_w(r) + A_{c,w}^e(r) + \sum_{r=1}^R T_{w,R}(r) + G_h(r) = C_w(r) \quad \sum_{r=1}^R T_w(r) + A_{c,w}^e(r) + \sum_{r=1}^R T_{w,R}(r) + G_h(r) = C_w(r) \quad (9)$$

If the energy produced from RES extended beyond the demand $T_w(r) > C_w(r)$, then smart energy consumers stored the surplus energy in energy storage systems. The ESS stored energy is bounded as $W_{a,w}^{w,min} \leq W_{a,w}^e(r) \leq W_{a,w}^{w,max}$, where $G_h(r)$ represents the power got at each timeslot from the power grid, $T_{w,R}(r)$ denotes neighbor TEC borrowed energy at each timeslot, and $W_{a,w}^e(r)$ denotes the original energy stored by the smart energy consumer in energy storage systems.

The trading energy consumer (TEC) is satisfying their energy demand from RES, energy storage systems, and neighboring trading energy consumers, which can trade energy with users and the grid. The smart energy consumer's demand for power is $C_R(r)$ and constrained as $C_R(r) \leq C_{r, max}$. If energy harvested is unfulfilled $T_R(r) < C_R(r)$, the calculation of unsatisfied demand is evaluated as,

$$C_R(r) - T(R) = C_R^v(r) \quad (10)$$

The amount of energy borrowed from trading energy consumer neighbors, energy storage systems, and the smart grid is equivalent to the unfulfilled claim as follows,

$$A_{c,R}^e(r) + \sum_{r=1}^R T_{R,m}(r) + G_h(r) = C_R^v(r) \quad (11)$$

$$\sum_{r=1}^R T_R(r) + A_{c,R}^e(r) + \sum_{r=1}^R T_{R,m}(r) + G_h(r) = C_R(r) \quad (12)$$

As shown in the above Equations (11) and (12), where $C_R^v(r)$ denotes the TEC unfulfilled demand, $T_{R,m}(r)$ indicates exchange of energy among the TEC, and $A_{c,R}^e(r)$ indicates the drawn energy from ESS.

ESS are used to reduce fluctuations and to effectively use renewable energy and enhance the strength of the power system. The integration of RES using trading energy consumers and smart energy consumers has been grouped in ESS locations for energy optimization. The TEC and SEC ESS versions are as follows:

Energy storage system model for smart energy consumption: the energy storage system importantly includes in the RES effective energy integration that improves reliability and security in the pollution-free atmosphere. The proposed energy storage system model for premises of smart energy consumers is established as follows,

$$W_{a,w}^e(r+1) = W_{a,w}^e(r) - A_{c,w}^e(r) + W_w^e(r) \quad (13)$$

As inferred from Equation (13) where $W_{a,w}^e(r)$ denotes initial ESS energy stored, $W_w^e(r)$ indicates the quantity of energy storage system stored energy at each timeslot and $A_{c,w}^e(r)$ denotes the energy storage system energy constrained unit. The attributes of energy determined in energy storage system restrictions are expressed by,

$$A_{c,w}^e(r) \leq W_{a,w}^e(r) \quad (14)$$

The implementation of finite discharging, charging, and parameters of battery capacity at each slot of time are defined as,

$$\begin{cases} A_{c,w}^e(r) \leq w_{a,w}^{e,min} \\ W_{a,w}^{e,max} \geq 0 \quad W_{a,w}^{e,min} \geq 0 \\ W_{a,w}^{e,min} \leq W_{a,w}^e(r) \leq W_{a,w}^{e,max} \end{cases} \quad (15)$$

as shown in Equation (15) where $w_{a,w}^{e,min}$ denotes the battery discharge minimum unit, and $W_{a,w}^{e,max}$ indicates the finite battery charging capacity or maximum limit. The energy storage system capacity reflection is provided by,

$$W_{a,w}^{e,max} \geq A_{c,w}^{e,max} + W_{a,w}^{e,min} \quad (16)$$

as described in Equation (16) where $A_{c,w}^{e,max}$ represent the extreme power strained from the energy storage system.

Energy storage system has been optimized using trading energy consumption model to resolve renewable energy fluctuation. This simplifies the integration of RES effective energy for the removal of waste energy and enlargement of revenue. The charging of energy storage systems is implemented as follows,

$$W_{a,R}^e(r+1) = W_{a,R}^e(r) - A_{c,R}^e(r) + W_R^e(r) \quad (17)$$

as inferred from Equation (17) where $W_{a,R}^e(r)$ indicates the original ESS energy stored at each slot of time r and $A_{c,R}^e(r)$ is the component of energy storage system strained energy. The attributes of energy determined in energy storage system restraints are provided as,

$$A_{c,R}^e(r) \leq W_{a,R}^e(r) \quad (18)$$

The ESS charging and discharging as constraints at upper and lower limits are defined as,

$$\begin{cases} A_{c,R}^e(r) \leq w_{a,w}^{e,min} \\ W_{a,w}^{e,max} \geq 0 \quad W_{a,R}^{e,min} \geq 0 \\ W_{a,R}^{e,min} \leq W_{a,R}^e(r) \leq W_{a,R}^{e,max} \end{cases} \quad (19)$$

as described in Equation (19), where $W_{a,w}^{e,min}$ denotes the lower limit of battery discharge. $W_{a,R}^{e,max}$ denotes the upper limit of finite charging capacity, and energy storage system battery charging and discharging at each slot of time is bounded between the two values. The real-time consideration of energy storage system capacity is calculated as,

$$W_{a,R}^{e,max} \geq A_{c,R}^{e,max} + W_{a,R}^{e,min} \quad (20)$$

as shown in Equation (20) where $A_{c,R}^{e,max}$ denotes the maximum power that can be stored in the trading energy consumers' energy storage systems.

The use of this proposed approach promotes the utilization of renewable energy sources for the financial benefit of consumers. The approach presented is therefore consistent with energy policy goals and aims to turn electricity into renewable energy. Further experimental results has been analyzed and the numerical results are discussed as follows.

4. Experimental Results and Discussion

4.1. Efficiency Factor Analysis

This study presents a method for efficient energy management of smart homes with energy storage systems and integration of renewable energy systems. The proposed FES-EESHM can efficiently decrease the peak-to-average ratio and cost of electricity with minimum peak load value. For this reason, a fuzzy expert system with a controller is suggested to control the consumption of energy, energy storage and production, schedule energy trading, and manage loads to reduce the power flow and cost of electricity. Figure 5 shows the efficiency factor analysis of the proposed FES-EESHM method.

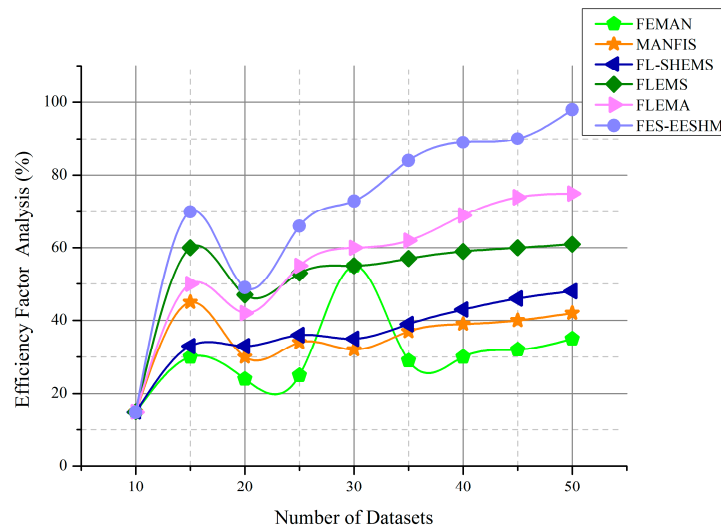

Figure 5. Efficiency factor analysis.

Table 1 shows the efficiency factor analysis of the proposed FES-EESHM method. The expert system helps users automate energy usage to improve the energy efficiency and economic efficiency of their systems. This increases consumer understanding of the applications of renewable sources of energy and reduction of CO₂. In the electricity sector, the suggested expert method will promote renewable resources under policies on renewable energy.

Table 1. Efficiency factor analysis.

Number of Datasets	FEMAN	MANFIS	FL-SHEMS	FLEMS	FLEMA	FES-EESHM
10	15.1	15.2	15.3	15.5	15.3	15.2
15	50.2	46.3	35.3	60.9	51.3	70.1
20	24.4	30.5	30.9	39.8	39.8	55.6
25	30.5	34.6	36.4	56.2	43.2	67.2
30	56.9	38.9	37.8	38.9	62.8	75.2
35	34.3	40.5	42.3	42.1	64.7	83.2
40	30.8	43.4	44.6	48.9	70.7	90.2
45	32.5	45.7	46.7	50.2	73.8	92.3
50	39.8	50.1	53.2	64.5	78.9	98.7

4.2. Energy Consumption Rate

Since the residential and tertiary industries are the most energy-intensive sectors, residential consumption is a key element in changes in the grid. The goal is to satisfy residential energy demand sustainably with local photovoltaic energy generation for users' comfort. An efficient home energy management system (HEMS) is needed for this; an integrated home energy management control system that manages appliances to reduce the electricity bill of the customer in response to dynamic price

signals, reducing energy use, and taking into account user comfort. The proposed FES-EESHM method minimizes the energy consumption in a smart home utilizing effective scheduling from renewable energy resources such as wind and photovoltaic panels. Figure 6 shows the energy consumption rate of the proposed FES-EESHM method.

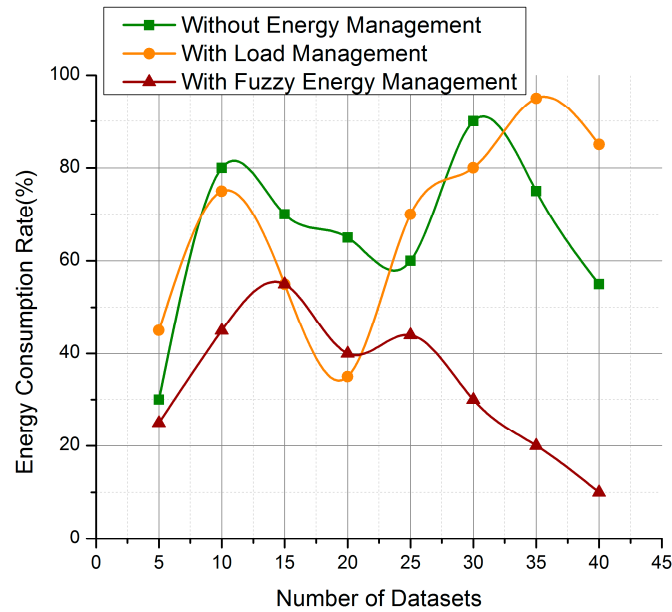

Figure 6. Energy consumption ratio.

4.3. Electricity Cost

Levelised cost of energy (LCE) is an economic assessment method that encompasses both recurrent and non-recurring costs over the life of a project for energy production in an integrated system. The ratio between the total annualized system cost and the yearly electricity production is specified. Its purposes are variable consumption, variable output, and variable price of electricity for using fuzzy logic in this article. Due to its simplicity and broad application and tolerance for inexact data, fuzzy logic is selected. Contrary to many time-consuming optimization approaches, fuzzy logic can work in real time. Concurrent decision-making with the simplified data is possible with the application of fuzzy logic. Fuzzy logic allows users to modify the rules and alter the function of the controller because it is related to linguistic expressions. Figure 7 shows the electricity cost of the proposed method.

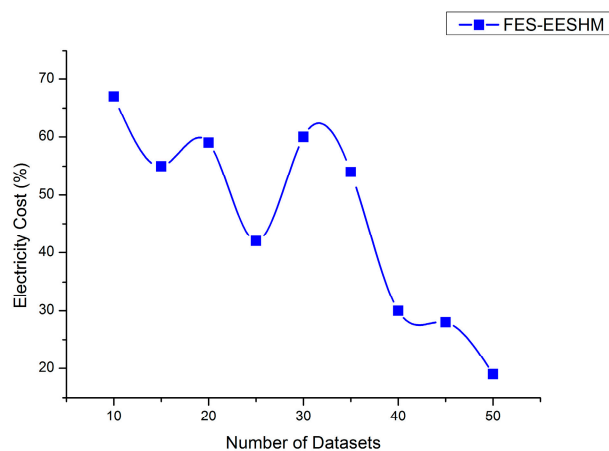

Figure 7. Electricity cost.

4.4. Loads Percentage in Peak Hours

Concerning monetary cost reductions, it is important to note that electricity distribution companies around the world have adopted multiple tariff systems for handling peak loads. The proposed scheme in this paper is based on a time-of-use tariff, which results in different tariff pricing rates for different hours. It considers appliances' contribution to average peak loads and the average consumer delay, together with the advantages of a fuzzy approach that seeks to achieve the best balance between demand and energy usage. It has been demonstrated by simulation findings that the proposed solution tackles new research problems that are exploring online user input methods and approaches. Our proposed solution will be quite effective in terms of contributions to a level of user comfort, minimizing the time factors of such a system, reducing demand for electricity and peak load consumption charges, and allowing a meaningful cost reduction to be achieved. Figure 8 shows the loads percentage in peak hours of the proposed FES-EESHM method.

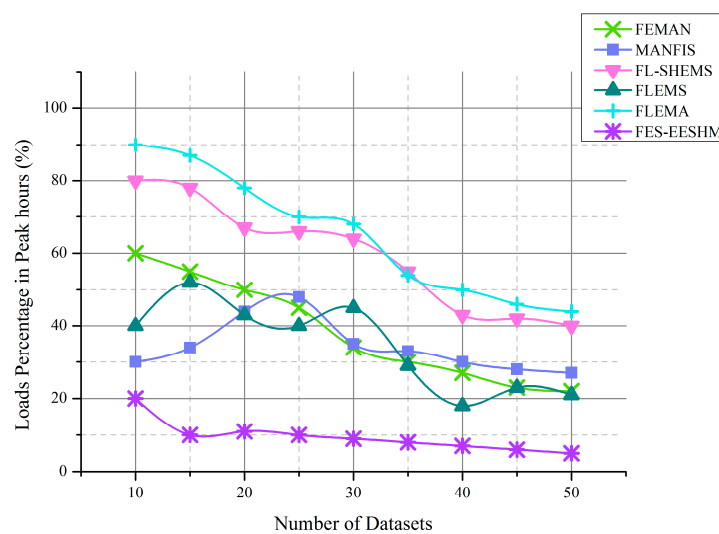

Figure 8. Loads percentage in peak hours.

4.5. Relative Error Rate

It is desirable to utilize fuzzy logic systems in which the input or output data are not clearly stated, calculated, or forecast with specific errors. The distributed output from both renewable and power sources depends on the environment and temperature-related conditions. Electricity prices change every day, and dynamic prices are increasingly popular. Therefore, electricity consumption is based on the random use of various electrical equipment. The proposed FES-EESHM method has a lower relative error rate when compared to other existing FEMAN, MANFIS, FLSHEMS, FLEMS, and FLEMA approaches. Figure 9 demonstrates the relative error rate of the proposed FES-EESHM method.

The experimental results demonstrate that the suggested fuzzy expert system for efficient energy smart home management systems (FES-EESHM) has high efficiency, is cost-effective, has a low error rate, and low energy consumption when compared to other existing FEMAN, MANFIS, FLSHEMS, FLEMS, and FLEMA methods.

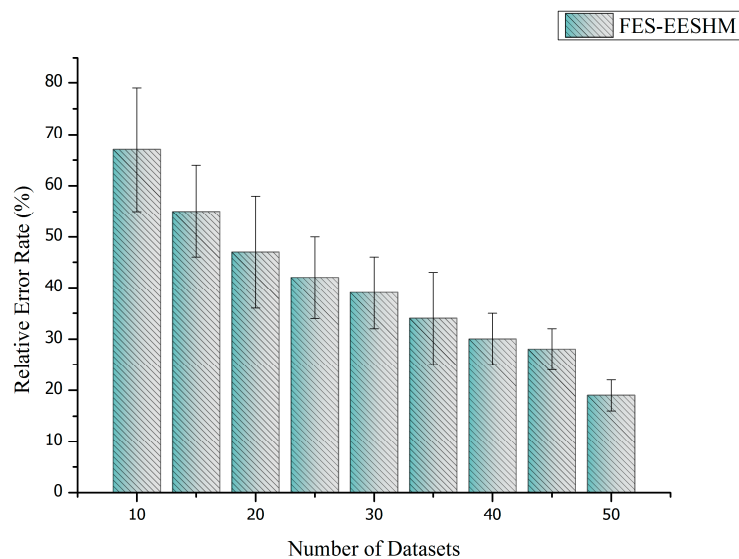

Figure 9. Relative error rate.

5. Conclusions

This article presents a fuzzy expert system for efficient energy smart home management systems (FES-EESHM), which have been proposed for renewable energy resources. Integrated renewable energy systems are known in independent applications as a feasible option for energy supply. To confirm the results, the proposed system can be validated with input of daily data attributes. The data input can be constantly changed to run the controller in real time and control future behavior. The control system has been validated utilizing realistic measured data on insolation, wind speed, electricity pricing, and charging power input variables, taking into account the energy generated from storage capacity, renewable sources, and controlled loads. After a comparative study carried out with certain previously used optimization approaches, we found that, compared with the optimization approaches, the control unit not only produced the same optimal results but has additional advantages. The proposed controller is widely understandable, flexible, and does not need any computation models of the controlled model, given that a set of rules is stated as linguistic variables. Therefore, the controller will work via a continuous modification of the input data in real time, some of which can be used to predict the system's future behaviors. Renewables are developing ever faster, contributing to a climate change transition, ensuring access to energy for all, reducing air emissions, and improving energy safety.

Author Contributions: Conceptualization, Methodology, Software, R.Z., Data curation, Writing—Original draft preparation, S.V.E., Writing—Reviewing and Editing, Visualization, and Investigation R.D.J.S. All authors have read and agreed to the published version of the manuscript.

Funding: This research was funded by [Research on cultural trade policy and implementation approach of Shaanxi free trade zone] grant number [2019ZD07] And The APC was funded by [Major special project of Shaanxi Social Science Fund]; and funded by [Research on the new model of industrial Poverty Alleviation under the requirement of high quality development] grant number [2018KRLZ05] And The APC was funded by [Department of science and technology of Shaanxi Province].

Conflicts of Interest: The authors declare that have no conflict of interest.

References

1. Parvizimosaed, M.; Farmani, F.; Anvari-Moghaddam, A. Optimal energy management of a micro-grid with renewable energy resources and demand response. *J. Renew. Sustain. Energy* **2013**, *5*, 053148. [CrossRef]
2. Collotta, M.; Pau, G. A solution based on bluetooth low energy for smart home energy management. *Energies* **2015**, *8*, 1916. [CrossRef]
3. Chen, Y.K.; Wu, Y.C.; Song, C.C.; Chen, Y.S. Design and implementation of energy management system with fuzzy control for DC microgrid systems. *IEEE Trans. Power Electron.* **2012**, *28*, 1563–1570. [CrossRef]

4. Sianaki, O.A.; Masoum, M.A. A multi-agent intelligent decision making support system for home energy management in smart grid: A fuzzy TOPSIS approach. *Multiagent Grid Syst.* **2013**, *9*, 181–195. [[CrossRef](#)]
5. Arcos-Aviles, D.; Pascual, J.; Guinjoan, F.; Marroyo, L.; Sanchis, P.; Marietta, M.P. Low complexity energy management strategy for grid profile smoothing of a residential grid-connected microgrid using generation and demand forecasting. *Appl. Energy* **2017**, *205*, 69–84. [[CrossRef](#)]
6. Ciabattini, L.; Grisostomi, M.; Ippoliti, G.; Longhi, S. Fuzzy logic home energy consumption modeling for residential photovoltaic plant sizing in the new Italian scenario. *Energy* **2014**, *74*, 359–367. [[CrossRef](#)]
7. Allahvirdizadeh, Y.; Mohamadian, M.; HaghiFam, M.R.; Hamidi, A. Optimization of a fuzzy based energy management strategy for a PV/WT/FC hybrid. *Int. J. Renew. Energy Res. (IJRER)* **2017**, *7*, 1686–1699.
8. Jafari, M.; Malekjamshidi, Z.; Lu, D.D.C.; Zhu, J. Development of a fuzzy-logic-based energy management system for a multiport multioperation mode residential smart microgrid. *IEEE Trans. Power Electron.* **2018**, *34*, 3283–3301. [[CrossRef](#)]
9. Ain, Q.U.; Iqbal, S.; Khan, S.A.; Malik, A.W.; Ahmad, I.; Javaid, N. IoT operating system based fuzzy inference system for home energy management system in smart buildings. *Sensors* **2018**, *18*, 2802. [[CrossRef](#)] [[PubMed](#)]
10. De Angelis, F.; Boaro, M.; Fuselli, D.; Squartini, S.; Piazza, F.; Wei, Q. Optimal home energy management under dynamic electrical and thermal constraints. *IEEE Trans. Ind. Inform.* **2012**, *9*, 1518–1527. [[CrossRef](#)]
11. Jafari, M.; Malekjamshidi, Z.; Platt, G.; Zhu, J.G.; Dorrell, D.G. A multi-port converter based renewable energy system for residential consumers of smart grid. In Proceedings of the IECON 2015-41st Annual Conference of the IEEE Industrial Electronics Society, Yokohama, Japan, 9–12 November 2015.
12. Ainsworth, N.; Johnson, B.; Lundstrom, B. A fuzzy-logic subsumption controller for Home Energy Management Systems. In Proceedings of the 2015 North American Power Symposium, Charlotte, NC, USA, 4–6 October 2015.
13. Singh, S.N.; Singh, A.K.; Swati, S.K.; Jha, R. Rural home energy management by fuzzy control model for utility interfaced autonomous solar (PV)–DG power system in India. *IJAEST* **2012**, *14*, 15–21.
14. Ciabattini, L.; Ferracuti, F.; Grisostomi, M.; Ippoliti, G.; Longhi, S. Fuzzy logic based economical analysis of photovoltaic energy management. *Neurocomputing* **2015**, *170*, 296–305. [[CrossRef](#)]
15. Tascikaraoglu, A.; Boynuegri, A.R.; Uzunoglu, M. A demand side management strategy based on forecasting of residential renewable sources: A smart home system in Turkey. *Energy Build.* **2014**, *80*, 309–320. [[CrossRef](#)]
16. Chehri, A.; Mouftah, H.T. FEMAN: Fuzzy-based energy management system for green houses using hybrid grid solar power. *J. Renew. Energy* **2013**, *2013*, 1–6. [[CrossRef](#)]
17. GK, J.S.; Jasper, J. MANFIS based SMART home energy management system to support SMART grid. *Peer-to-Peer Netw. Appl.* **2020**, *1*, 1–12.
18. Krishna, P.N.; Gupta, S.R.; Shankaranarayanan, P.V.; Sidharth, S.; Sirphi, M. Fuzzy Logic Based Smart Home Energy Management System. In Proceedings of the 2018 9th International Conference on Computing, Communication and Networking Technologies, Bengaluru, India, 10–12 July 2018.
19. Chekired, F.; Mahrane, A.; Samara, Z.; Chikh, M.; Guenounou, A.; Meflah, A. Fuzzy logic energy management for a photovoltaic solar home. *Energy Procedia* **2017**, *134*, 723–730. [[CrossRef](#)]
20. Breban, S.; Gros, I.; Marginean, C.; Teodosescu, P. Fuzzy logic energy management for a residential power system using renewable energy sources. *Mod. Fuzzy Control Syst. Appl.* **2017**, *127*, 1–12.



© 2020 by the authors. Licensee MDPI, Basel, Switzerland. This article is an open access article distributed under the terms and conditions of the Creative Commons Attribution (CC BY) license (<http://creativecommons.org/licenses/by/4.0/>).

© 2020. This work is licensed under <http://creativecommons.org/licenses/by/3.0/> (the “License”). Notwithstanding the ProQuest Terms and Conditions, you may use this content in accordance with the terms of the License.